

**CENTRAL MACHINERY**®

# 7" x 10" Mini Lathe

## Model 33684

Assembly and Operating Instructions

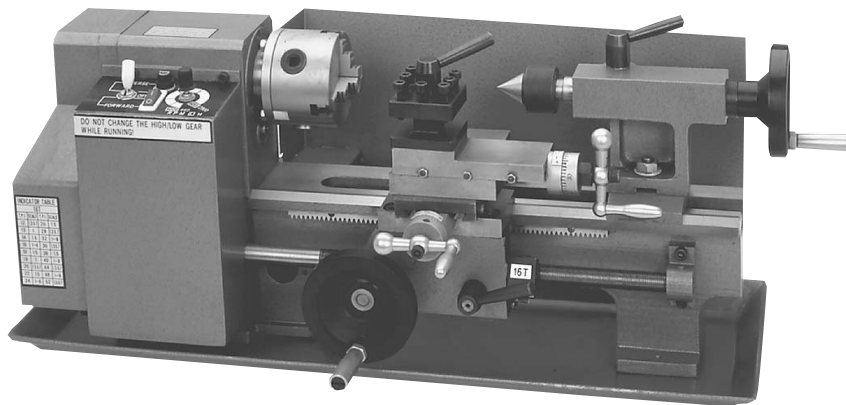

3491 Mission Oaks Blvd., Camarillo, CA 93011

Copyright ©2000 by Harbor Freight Tools®. All rights reserved. No portion of this manual or any artwork contained herein may be reproduced in any shape or form without the express written consent of Harbor Freight Tools.

**For technical questions and replacement parts, please call 1-800-444-33534.**

## Important Safety Instructions

**READ ALL INSTRUCTIONS AND WARNINGS BEFORE USING THIS TOOL.**

### Operator

COMMON SENSE AND CAUTION ARE FACTORS WHICH CANNOT BE BUILT INTO ANY PRODUCT. THESE FACTORS MUST BE SUPPLIED BY THE OPERATOR. PLEASE REMEMBER:

1. When using electric tools, machines or equipment, basic safety precautions should always be followed to reduce the risk of fire, electric shock, and personal injury.
2. Keep work area clean. Cluttered areas invite injuries.
3. Consider work area conditions. Do not use machines or power tools in damp, wet, or poorly lit locations. Do not expose equipment to rain. Keep work area well lit. Do not use tools in the presence of flammable gases or liquids.
4. Keep children away. All children should be kept away from the work area.
5. Guard against electric shock. Prevent body contact with grounded surfaces such as pipes, radiators, ranges, and refrigerator enclosures.
6. Stay alert. Never operate equipment if you are tired.
7. Do not operate the product if under the influence of alcohol or drugs. Read warning labels on prescriptions to determine if your judgment or reflexes might be impaired.
8. Do not wear loose clothing or jewelry as they can be caught in moving parts.
9. Wear restrictive hair covering to contain long hair.
10. Use eye and ear protection. Always wear:
  - ANSI approved chemical splash goggles when working with chemicals.
  - ANSI approved impact safety goggles at other times.
  - ANSI approved dust mask or respirator when working around metal, wood, and

chemical dusts and mists.

-A full face shield if you are producing metal or wood filings.

11. Keep proper footing and balance at all times.
12. Do not reach over or across running machines.
13. Always check that adjusting keys and wrenches are removed from the tool or machine work surface before plugging it in.
14. Do not carry any tool with your finger on either the start button or trigger.
15. When servicing, use only identical replacement parts.

### Before Operation

1. Be sure the switch is OFF when not in use and before plugging in.
2. Do not attempt to use inappropriate attachments in an attempt to exceed the tool's capacity. Approved accessories are available from Harbor Freight Tools.
3. Check for damaged parts. Before using any tool, any part that appears damaged should be carefully checked to determine that it will operate properly and perform its intended function.
4. Check for alignment and binding of all moving parts, broken parts or mounting fixtures and any other condition that may affect proper operation. Any part that is damaged should be properly repaired or replaced by a qualified technician.
5. Do not use the tool if any switch does not turn off and on properly.

## Operation

1. Never force the tool or attachment to do the work of a larger industrial tool. It is designed to do the job better and more safely at the rate for which it was intended.
2. Do not carry the tool by its power cord.
3. Always unplug the cord by the plug. Never yank the cord out of the wall.
4. Always turn off the machine before unplugging.

**IF THERE IS ANY QUESTION ABOUT A CONDITION BEING SAFE OR UNSAFE, DO NOT OPERATE THE TOOL!**

## Grounding Instructions and Voltage Warning

Common household current is 110-120 volts. As long as your tool is rated from 110-120V there will be no complications using this tool with household receptacles. NEVER try to plug a 110-120V tool into a 220-240V circuit (or vice-versa) or serious complications and possible serious injury to the operator can occur. The plugs have different shapes to prevent this.

Check to see if your tool has a two or three-prong plug. If your tool has a two-prong plug, you may proceed past the next paragraph. If your tool has a three-prong plug, please continue reading the following precautions and instructions.

If the tool or machine has a three-prong plug, the third (round) prong is the ground. Plug this cord only into a three-prong receptacle. Do not attempt to defeat the protection the ground wire provides by cutting off the round prong. Cutting off the ground will result in a safety hazard and void the warranty.

If a three-prong receptacle is not available, you may use an adapter, but you must then connect the green ear on the adapter to the outlet. Unscrew the center screw of the outlet cover and put the screw through the green ear. Plug the adapter's two prongs into the outlet, and replace the center screw. Now plug the tool or machine into the adapter.

**DO NOT MODIFY THE PLUG IN ANY WAY. IF YOU HAVE ANY DOUBT, CALL A QUALIFIED ELECTRICIAN.**

## Extension Cords

If your tool is double insulated and has a two-prong plug, you may use either a two or three-prong extension cord. If your tool has a grounded, three-prong plug, you must use a three-prong extension cord with three-prong receptacles. Only use rounded jacket extension cords listed by the Underwriters Laboratories (UL). If you are using the tool outdoors, use an extension cord rated for outdoor use (signified by "WA" on the jacket).

The extension cord must have a minimum wire size depending on the amperage of the tool and the length of the extension cord. The size is determined by its AWG (American Wire Gauge) rating. The smaller the gauge, the greater the cable's capacity. The amount of cords used does not matter. Total length determines the minimum AWG rating. Every cord must meet the AWG rating. Use the chart below to determine what AWG rating is required for your situation. Cord length is rated in feet. Harbor Freight Tools can supply UL listed and outdoor rated extension cords in multiple AWG ratings if needed.

AMP Rating	Total Extension Cord Length In Feet								
	25'	50'	75'	100'	125'	150'	175'	200'	
0.0 -10.0	18	18	16	16	14	14	12	12	
10.1-13.0	16	16	14	14	14	12	12	12	
13.1-15.0	14	14	12	12	12	12	12	--	
15.1-18.0	14	12	12	12	12	12	--	--	

## Additional Safety Rules for Mini Lathe

1. Before turning on the motor, make sure that proper lubrication is included (see page of this manual).
2. Always dismount the chuck and lathe's face plate by hand. Do not use power tools to perform these tasks.
3. After the chuck is installed, remove the wrenches and tools to eliminate the possibility of accident when the lathe is turned on.
4. Never adjust or fix workpieces or any rotating parts when the lathe is on. Never use instruments to measure the workpiece when the lathe is on. Never check the sharpness of the cutter by using your hand.
5. Avoid accidents resulting from broken workpieces. Never use an excessively large tool cutter to do feeding with a large workpiece.
6. Never change the gear when the lathe is in operation.
7. Always keep a safe distance from the lathe to minimize the risk of being struck by a broken workpiece.

---

**Thank you for choosing a Harbor Freight Tools product! For future reference, please complete the owner's record below:**

**Model:** \_\_\_\_\_ **Serial Number:** \_\_\_\_\_ **Purchase Date:** \_\_\_\_\_

SAVE THE RECEIPT, WARRANTY AND THESE INSTRUCTIONS. It is important that you read the entire manual to become familiar with the unit BEFORE you begin assembly.

---

## Technical Specifications

**Motor:** 3/4 Horsepower  
**Power Source:** 110V, Single Phase  
**Lathe Specifications:**  
Drive: Gear and Belt  
Swing Over Bed: 7"  
Distance Between Centers: 10"  
Spindle Bore: 3/4"  
Quill Travel: 2"  
Cross Slide Travel: 2 3/4"  
Cross Slide Swing: 4 1/2"  
Work Tolerance: .005"  
Bed Dimensions: 15 7/8" long, 3 1/4" wide  
Saddle Travel: 6 7/8"  
Compound Travel: 2 7/8"

## Unpacking

Carefully unpack the Mini Lathe and check all items. Figure 1 below shows all the contents of the carton. Do not discard any packing material until the Mini Lathe is fully assembled and operational. If any parts are missing or broken, please call Harbor Freight Tools at 1-800-444-3353. Be sure you have all parts described in the parts listing on page .

### Identification of Main Components

A. Lathe  
D. Chuck

B. Chuck Key  
E. Chuck Set Screws

C. External Jaws  
F. Internal Jaws

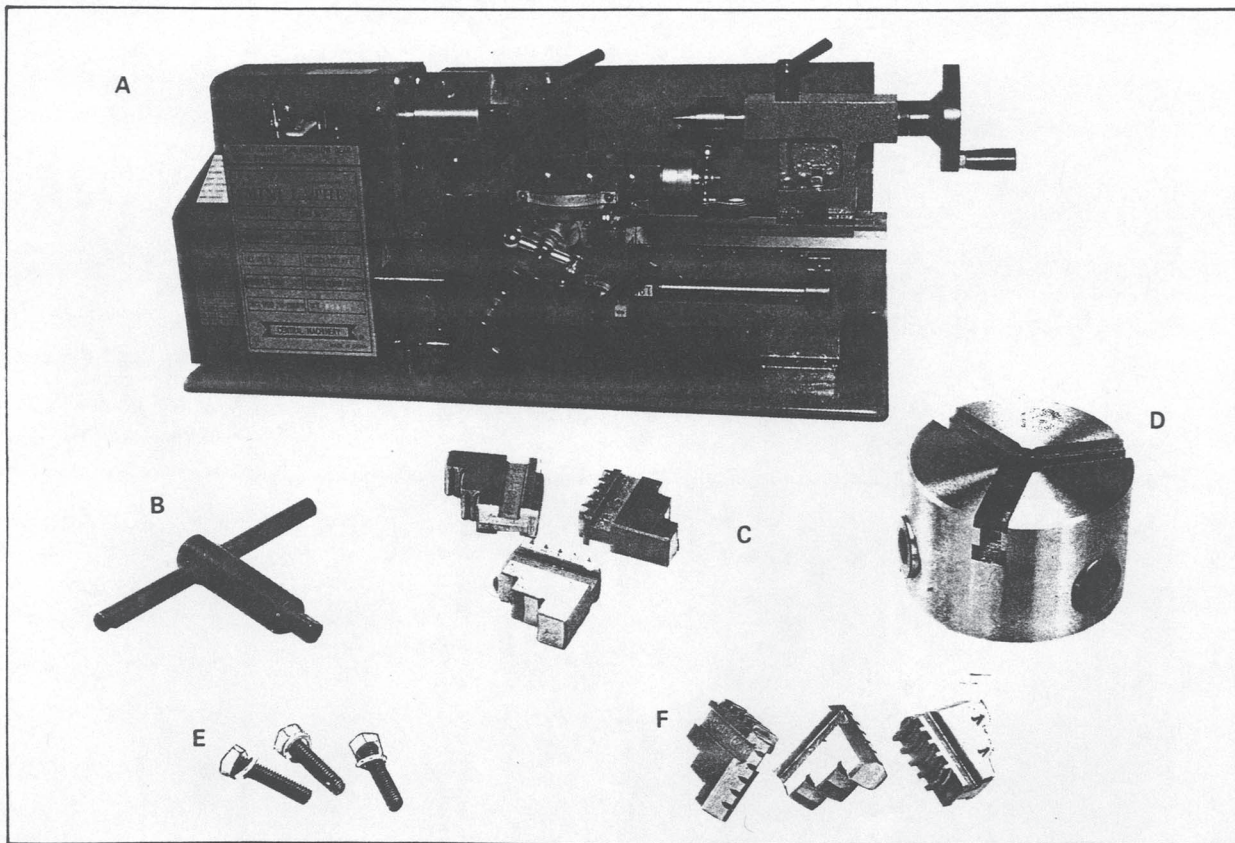
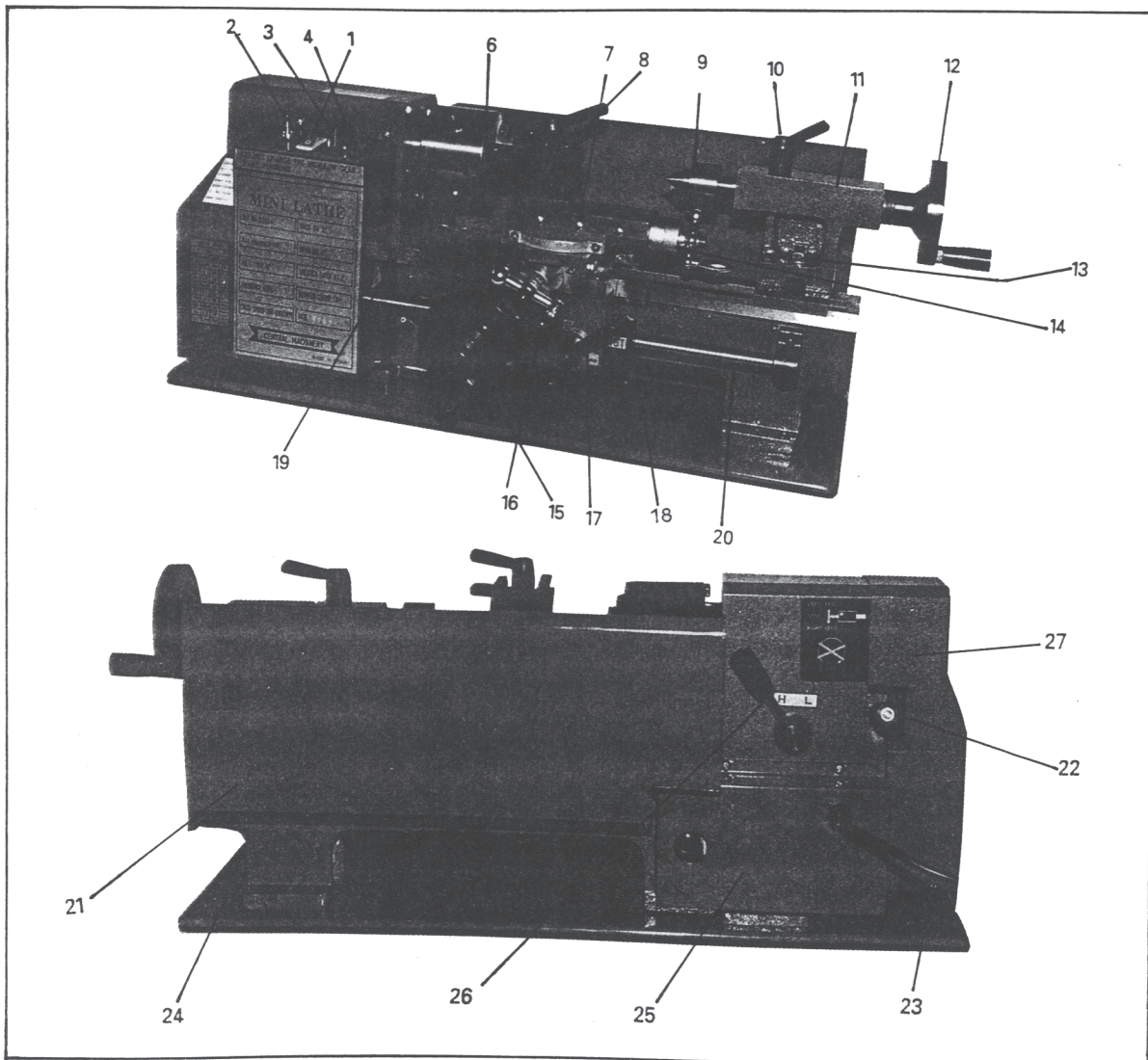

Fig. 1

## Mini Lathe Features

1. Power Switch
2. Power lamp
3. Fuse
4. Speed Control Knob
6. Chuck
7. Compound Rest
8. Tool Post
9. Fixed Center
10. Tailstock Quill Fix Holder
11. Tailstock
12. Tailstock Quill Adjust Handwheel
13. Tailstock Set Screw
14. Compound Rest Crank
15. Feeding Control Wheel
16. Cross Feeding Crank
17. Automatic Feeding Handle
18. Thread Dial Indicator
19. Bed Way
20. Lead Screw
21. Rear Splash Guard
22. Feeding Direction Selector
23. Power Cord
24. Chip Tray
25. Motor Cover
26. H/L Gear Shift Lever
27. End Cover



## Adjusting the Mini Lathe

1. Clean off the protective grease on the Mini Lathe.
2. Check to see that the three set screws on the chuck are tight.
3. Turn the chuck by hand and check that it rotates freely.
4. Move the Feeding Direction Selector (located on the back of lathe) to the middle.
5. Make sure the Switch (#1 in figure 4 below) is at the OFF position.

**WARNING: ADJUST THE SPEED CONTROL KNOB (#4) BY TURNING IT TO ZERO. BEFORE TURNING ON THE MINI LATHE EACH TIME IT IS TO BE USED, THIS SPEED CONTROL KNOB MUST BE AT ZERO.**

6. Plug in the electrical cord and turn the Switch to the ON position and run the lathe for 3 minutes. When the lathe is on, the Power Lamp (#2) will remain on. Check to see that the lathe operates normally.

7. Check the Compound Rest Crank and the Cross Feeding Crank to see that they work properly. If the cranks are too tight or too loose, turn the adjusting screws located at both sides (see figure 5 below).

**WARNING: THE MINI LATHE MUST BE COMPLETELY STOPPED BEFORE CHANGING FORWARD/REVERSE DIRECTION.**

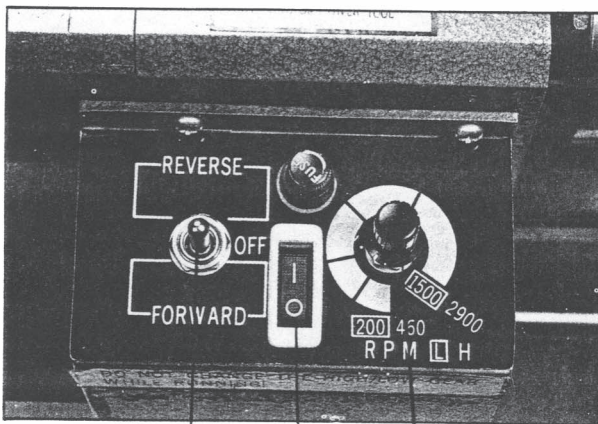

Fig. 4

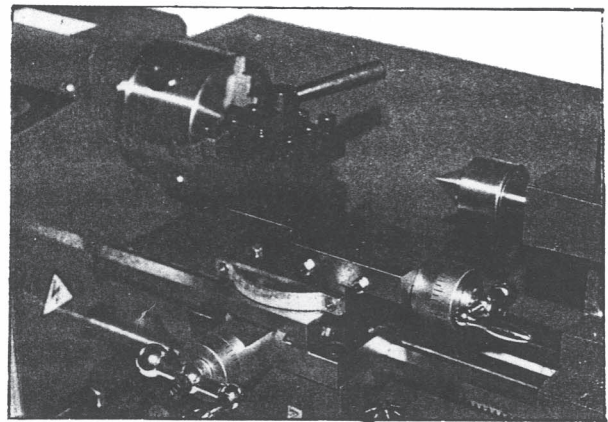

Fig. 5

## Replacement of Chuck

When replacing the chuck, place a cloth or a piece of wood on the bedway at the bottom of the chuck. This step will help avoid damage to the bedway caused by carelessly dropping the chuck. To replace the chuck, loosed the 3 set screws as shown in figure 6 below.

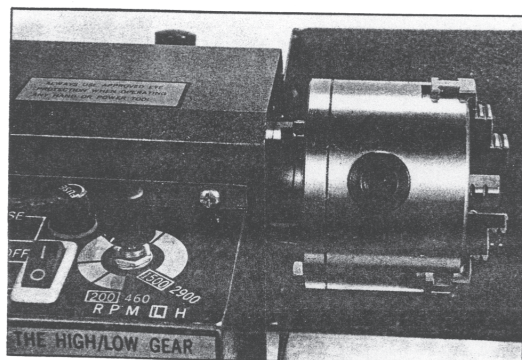

Fig. 6

## Replacement of Jaws

There are two types of jaws: the internal jaws and external jaws. Please note that the number of jaws fit with the number inside the chuck's groove. Do not mix them together.

When you are going to mount the jaws, mount them in ascending order. When they are taken out, make sure to take them out in descending order (3-2-1) one by one. After you finish this procedure, rotate the jaws to the smallest diameter and check that the three jaws are well fitted (see figure 7).

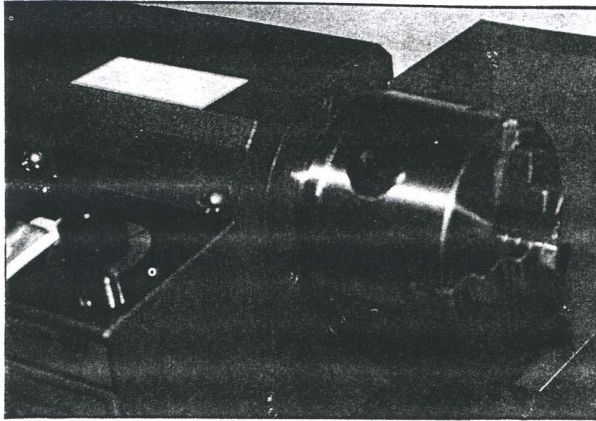

Fig. 7

If the jaws do not fit well together, you will need to reassemble them again.

When mounting a workpiece, it is recommended that all three jaws are loosened at the same time. This will protect the threads inside.

## Compound Rest Adjustment

To adjust the compound rest, loosen the two screws as shown in figure 8 (A). After adjusting to the required angle, tighten the screws.

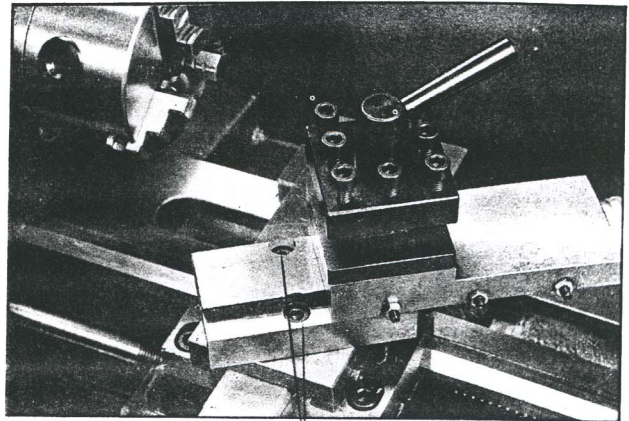

Fig. 8

## Tailstock Rest Adjustment

To change position or replace the tailstock, loosen the nut as shown in (A) of figure 9.

## Replacement of Carbon Brushes

To replace, remove brush covers on the motor cover (A) in figure 10-A, and the right bottom side of speed controller as shown in (B) of figure 10-B.

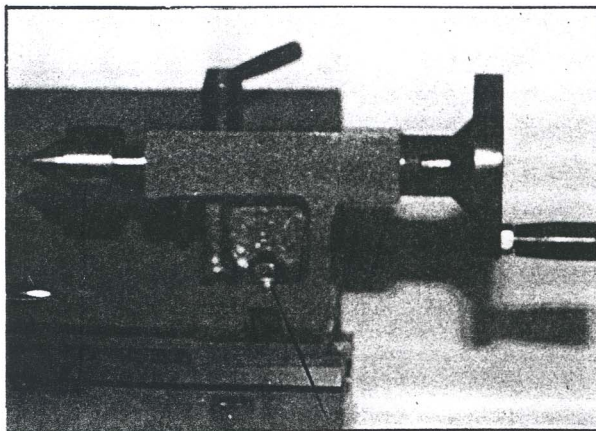

Fig. 9

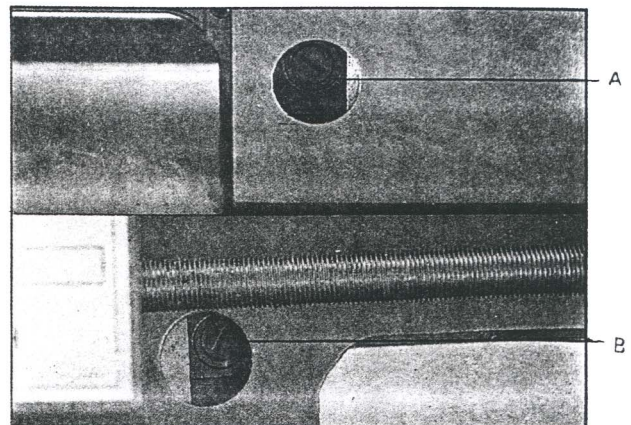

Fig. 10-A  
Fig. 10-B



## Tool Post Adjustment

Loosen the lever shown in (B) of figure 11, then adjust the tool post position. Once the adjustment is made, re-tighten the lever. To replace the work cutter, loosen the screws (A) with the allen wrench provided.

## Automatic Feeding

Adjust the feeding direction selector to the direction you desire. Press down the handle (A) in figure 12, and continue with the automatic feeding procedure. When feeding, never try to change the feeding direction.

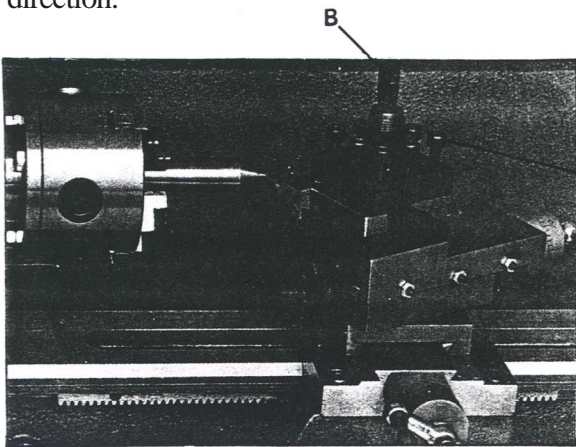

Fig. 11

## Threading

Select the feeding direction selector to the thread direction desired. Then press down handle (A) in figure 12 by matching the right calibrations on the thread dial indicator (B) and continue with the automatic threading procedure. When threading, never try to change the direction.

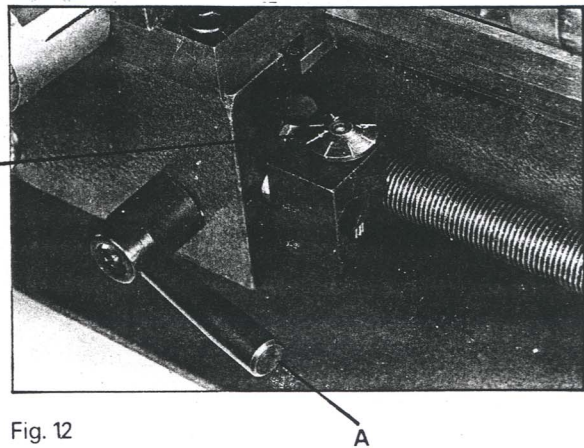

Fig. 12

# Operation

1. Use the chuck to hold the workpiece firmly (figure 13 below). Then, use the rolling center to fix the other end. If you change the rolling center to drilling chuck you start your drilling immediately.

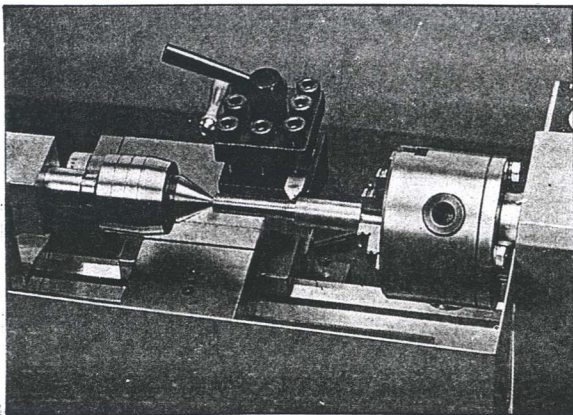

Fig. 13.

2. Use the chuck to hold the workpiece firmly and cutter to start lathe's face cutting (figure 14). The edge of the cutter must be at the same height as the center.

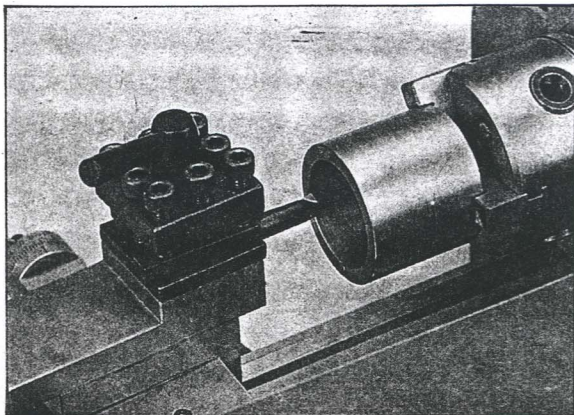

Fig. 14

3. By changing the tool post angle and adjusting the compound rest, you can do internal cutting (figure 15).

4. After adjusting the angle of the compound rest, you can do bevel cutting (figure 16).

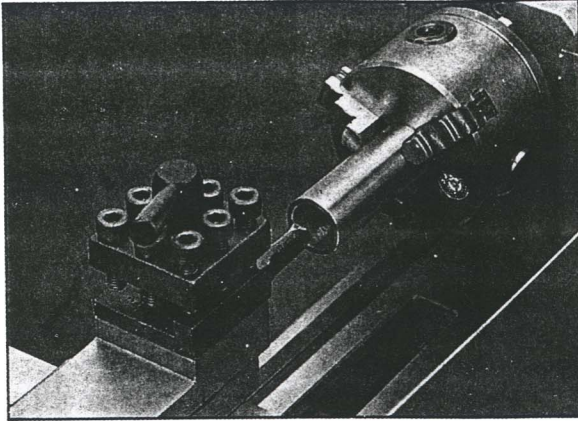

Fig. 15

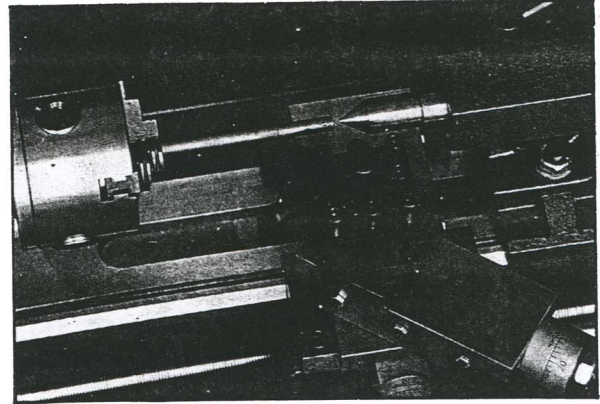
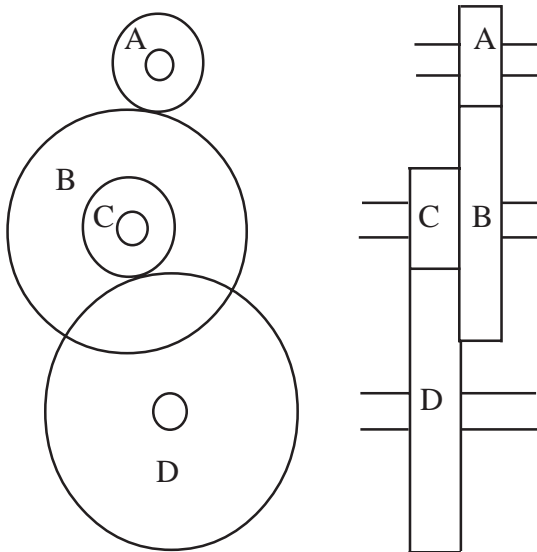

Fig. 16

### Set-Up Instructions for Threading Gears

By changing the gear set-up it is possible to cut any thread size. The factory set-up for Mini Lathe gears is as follows (see illustration below):



Position A= 20T  
Position B= 80T  
Position C= 20T  
Position D= 80T

To change the thread size, use the gear box settings shown on the table on the next page.

## Gear Settings for Various Thread Sizes

Threads Per Inch	Stud Gear Box			
	A	B	C	D
12	40			30
13	40	65	60	30
14	40			35
16	40			40
18	40			45
19	40	50	60	57
20	40			50
22	40			55
24	40			60
26	40			65
28	20			35
32	20			40
36	20			45

Threads Per Inch	Stud Gear Box			
	A	B	C	D
38	20	50	60	57
40	20			50
44	20			55
48	20			60
52	20			65
56	20	35	30	60
64	20	40	20	40
72	20	45	20	40
76	20	50	30	57
80	20	50	20	40
88	20	55	20	40
96	20	60	20	40
104	20	65	20	40

Example: To cut 12 threads per inch (see illustration below), use 40T in position A, 30T in position D, and put any other gear in position B to connect A and D.

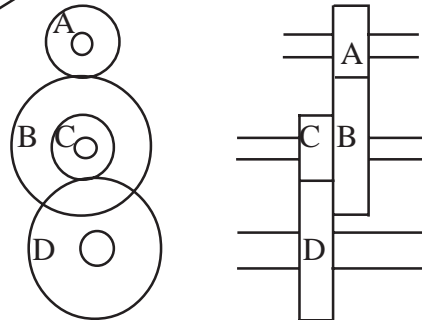
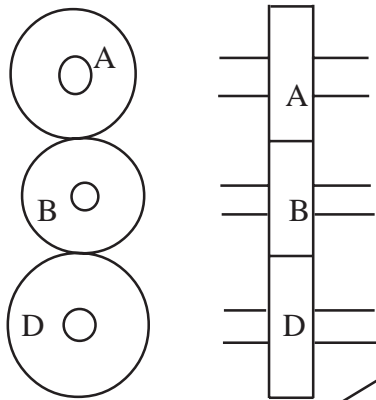

Example: To cut 38 threads per inch (see illustration above), use 20T in position A, 57T in position D, 50T in position B, and 60T in position C.

Ref. No.	Description	Part No.	Ref. No.	Description	Part No.
1	Bed Way	1	40	Support Screw	2
2	Chuck	1	41	Pinion 20T	1
3	Spindle	1	42	Fixed Cover	1
4	Screw M6x30	3	43	Screw M6x20	2
5	Washer M6	3	44	Screw M5x10	1
6	Nut M6	5	45	Gear 45T	1
7	Key M5x35	1	46	Shaft	1
8	Key M4x8	2	47	Parallel Key 3x8	1
9	Screw M5x10	6	48	Mount	1
10	Cover	2	49	Screw M5x16	2
11	Ball Bearing 6206ZZ	2	50	Pinion 20T	2
12	Spacer	2	51	Washer M6	6
13	Head Stock Casting	1	52	Screw M6x6	4
14	H/L Gear 21T/29T	1	53	Cover	1
15	Spacer	1	54	Screw M6x45	2
16	Spur Gear 45T	1	55	Threads Cutting Table	1
17	Nut	1	56	Screw M5x8	12
18	Set Screw M5x8	1	57	Washer M4	2
19	Steel Ball Ø5	2	58	Bush w/Key	1
20	Compression Spring Ø4.9x9	3	59	Gear 80T	2
21	Set Screw M6x6	3	60	Shaft	1
22	Retaining Ring M12	2	61	Support Plate	1
23	Ball Bearings 6201ZZ	2	62	Washer M8	2
24	H/L Gear 12T/20T	1	63	Nut M8	3
25	Parallel Key M4x45	1	64	Shaft	1
26	H/L Gear Shaft	1	65	Thread Dial Indicator	1
27	Pulley	1	66	Pinion 16T	1
28	Retaining Ring M10	2	67	Screw M6x16	11
29	Timing Belt Lx136	1	68	Indicator Housing	1
30	Shifting Fork	1	69	Set Screw M4x10	3
31	Shifting Arm	1	70	Apron	1
32	Shifting Knob	1	71	Gib Strip	1
33	Shifting Lever	1	72	Washer	2
34	Shifting Grip	1	73	Screw M4	2
35	Handle	1	74	Shaft	2
36	Handle Mount	1	75	Half Nut Base	2
37	Spring	1	76	Angle Block	1
38	Indicator	1	77	Screw	2
39	Pinion 25T	1	78	Groove Cam	1

Ref. No.	Description	Part No.	Ref. No.	Description	Part No.
79	Handle	1	118	Thurst Bearing Steel Ball	2
80	Shaft	1	119	Nut M18	2
81	Feeding Gear(A) 11T/54T	1	120	Model Label	1
82	Feeding Gear(B) 24T	1	121	Warning Label	1
83	Screw M6x12	4	122	Switch Label	1
84	Wheel	2	123	Control Box	1
85	Knob	2	124	Plug w/Cord	1
86	Handle	2	125	Rubber Pad	4
87	Dial	2	126	Chip Tray	1
88	Bracket	1	127	Bracket	1
89	Feeding Screw	1	128	Key M3x16	1
90	Nut M5	4	129	Lead Screw	1
91	Screw M6x12	6	131	Bracket	1
92	Slide Plate	2	132	Plastic Plug	1
93	Saddle	1	133	Screw M4x10	5
94	Gib Strip	1	134	Rack	1
95	Feeding Nut	1	135	Clamp Plate	1
96	Swivel Disk	1	136	Washer M10	1
97	Screw M8x20	2	137	Screw M6x16	1
98	Nut M4	6	138	Tailstock Casting	1
99	Screw M4x16	6	139	Tailstock Screw	1
100	Cross Slide	1	140	Bracket	1
101	Screw M5x10	2	141	Screw M4x12	1
102	Screw M4x10	2	142	Tailstock Quill	1
105	Compound Rest (B)	1	143	Rolling Center	1
106	Screw M4x16	1	144	Stud M8x35	1
107	Gib Strip	1	145	Clamp	1
108	Compound Rest (A)	1	146	Handle	1
109	Positioning Pin	1	147	Retaining Ring M8	1
110	Screw M8x25	11	148	Pulley	1
111	Clamping Lever	1	149	Key M3x16	1
112	Tool Rest	1	150	Motor	1
113	Stud M10x65	1	151	Cover	1
114	Cross Feeding Screw	1	152	Cord Fixer	1
115	Bracket	1	153	Rear Splash Guard	1
116	Screw M4x14	2	154	Warning Label	1
117	Thurst Bearing Cover	2	155	H L Label	1
			156	Warning Label	1

# Parts Diagram

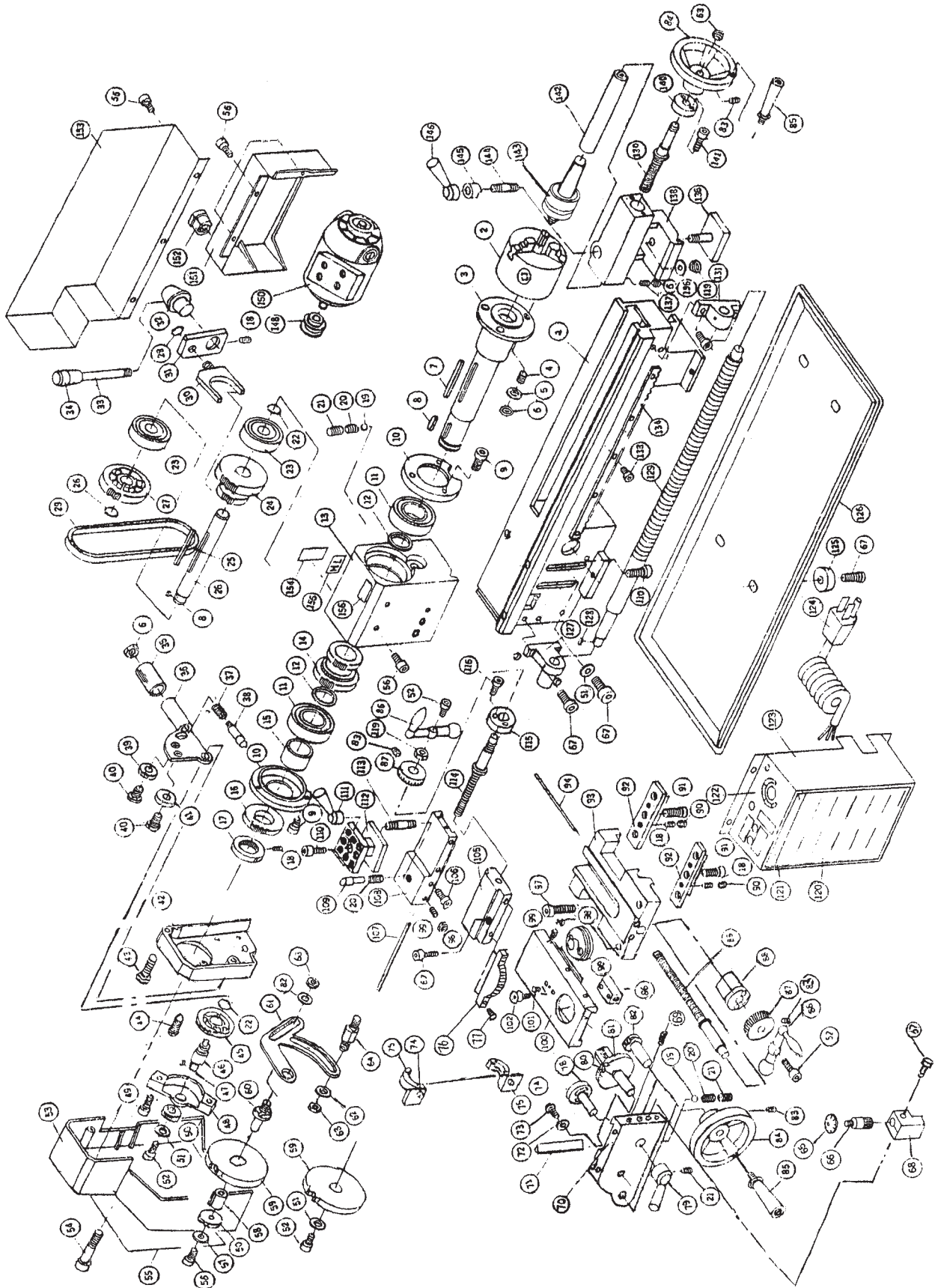

## Additional Set-Up Instructions for Threading Gears

When the lathe is ON and the Spindle is revolving, the threaded bar and the Thread Dial Indicator will also be revolving (see below).

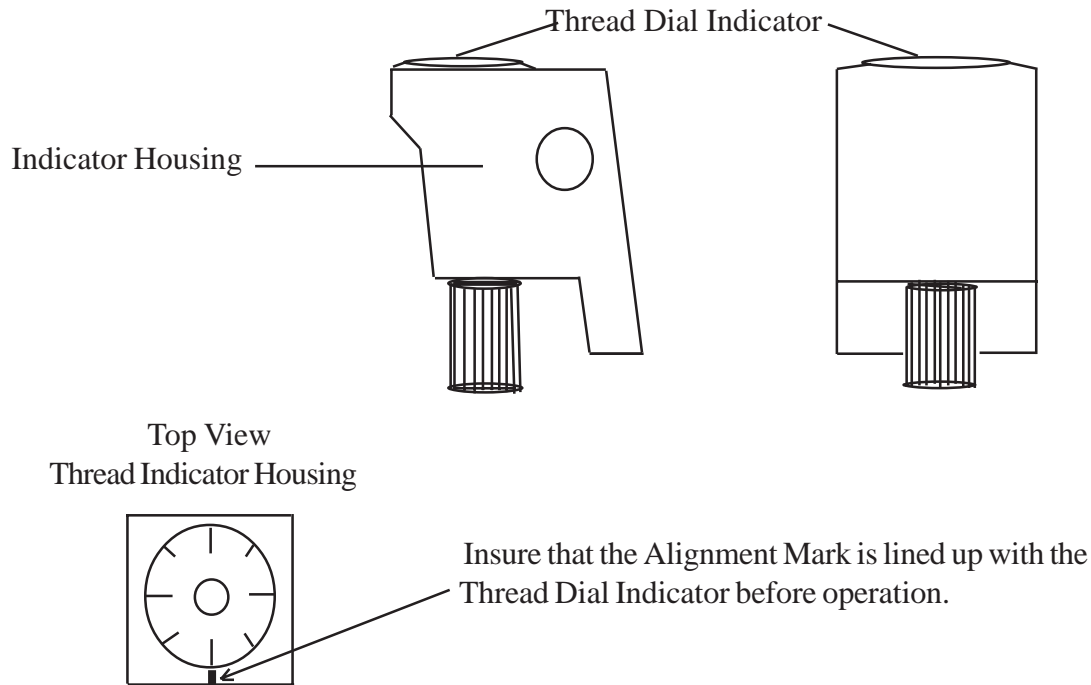

Move the cutting blade to the proper position, and adjust the Thread Dial Indicator to the desired mark. Pull down the Handle and the Mini Lathe starts threading automatically.

Remember: After thread cutting operation is complete, change back to the factory set-up gear setting:

- Position A= 20T
- Position B= 80T
- Position C= 20T
- Position D= 80T

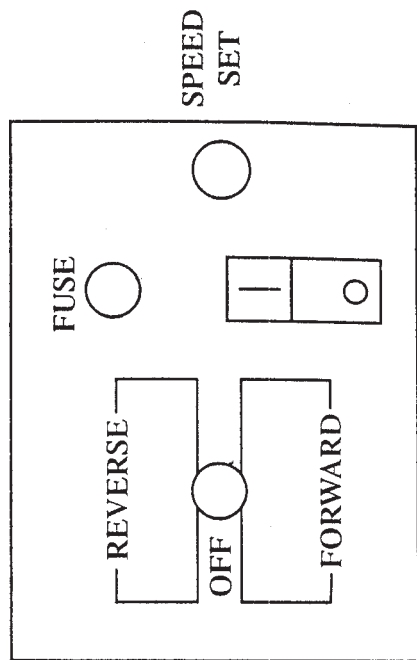

POWER SWITCH

MINI LATHE

WIRING DIAGRAM

OF CONTROL CIRCUIT

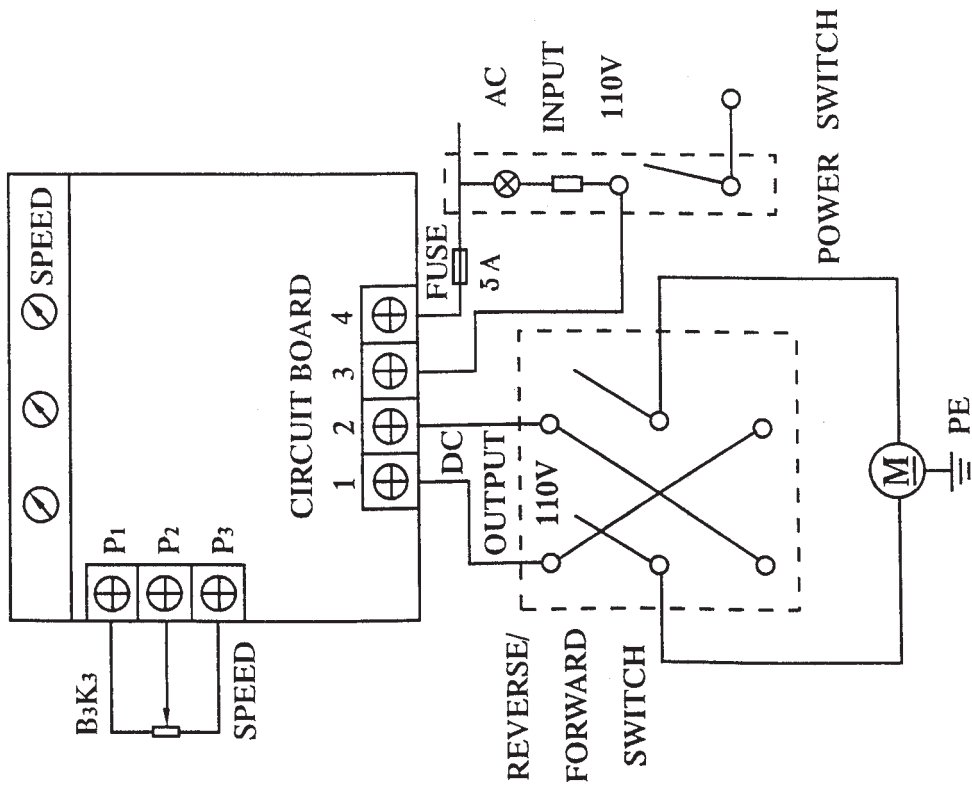



## PACKING LIST

No.	Description	Qty	Part No.
1	7" x 10" Mini Lathe	1 piece	
2	Chuck external jaws	3 piece	
3	Chueck Key	1 piece	
4	Fuse 5A	1 piece	
5	Gear Z: 30, 35, 40, 40, 45, 50, 55, 57, 60, 65	10 pieces	
6	Double head wrench 8-10, 14-17	2 pieces	
7	Inside six horn wrench S: 3, 4, 5, 6	4 pieces	
8	Oil can	1 piece	
9	Center MT: 2	1 piece	143
10	Rubber	4 pieces	125
11	Knob	2 pieces	85
12	Instruction Manual	1 copy	
13	Wiring Diagram of Control Circuit	1 copy	
14	Warranty Document	1 copy	

# SCHEMATIC DIAGRAM

